

Lolinn

14+

X26 *GYRO REMOTE CONTROL SERIES* 
2.4G

4-CHANNEL PRESSURE FIXED POSITION HOVERING REMOTE CONTROL DRONE

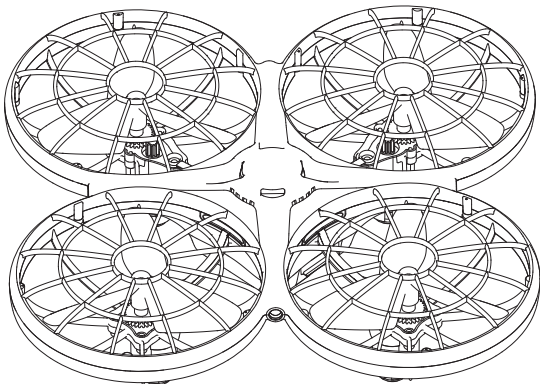

BC

USER MANUAL

Catalogue

English 01~22

Deutsch 23~44

Français 45~66

Italiano 67~88

Español 89~110

FLOW SENSOR

- Special 4-axis structure - fast and agile. Suitable for flying in spacious indoor and outdoor areas.
- Built-in 6-axis gyroscope, barometer and optical flow sensor ensures accurate position hold.
- Capable of doing 360 degrees stunts.
- Headless mode for easy flying.
- Pressure-fixed-position hovering function for Auto Hover Mode.
- Auto take-off and landing - easy and safe flying.
- New addition obstacle avoidance function

Safety Guide

1. Please, keep the small drone accessories out of reach of children.
2. This drone is very powerful. When flying for the first time, avoid sudden movements of the throttle. When ascending push the throttle stick slowly up to avoid unintended damages or injuries.
3. After flying, turn off the transmitter before turning off the drone .
4. Do not keep the batteries in high temperatures areas or near heat sources.
5. It is strongly recommended to operate the drone at 2-3 meters away from a pilot and other people or animals. Crashes may cause unintended injuries. When landing the drone, avoid crashing it into other people.
6. Adult or experienced RC pilot's supervision is recommended for children.

Safety Guide

7. Non-rechargeable batteries should not be recharged; Batteries should be inserted with a correct polarity; Different types of batteries, new or used batteries should not be mixing.
8. Turn off the drone/transmitter and remove the batteries when not in use.
9. The supply terminals are not be short-circuited
10. When not in use for more than 10 days, take measures to pro-long the drone's battery life by reducing the drone battery level to 40%-50% of it's capacity (fully charge the battery then fly the drone for half of it's flying time).
11. Keep away from the rotating blades (rotating blades may cause bodily injuries, or damage to property).
12. To avoid interfering with air traffic control signals avoid flying a drone within 5000 meters of an airport. Avoid operating RC equipment during the periods set by the local authority.
13. Only use the included charger.
14. Liquids can be used to clean the product. Turn off the equipment and unplug the charger from the power source before cleaning the drone. Perform routine inspection of the charger (check: port, shell and other parts) on a regular basis. If any abnormalities are found, immediately stop using the equipment until it is fixed.
15. Attention: please assemble the aircraft with the guidance of adults.
16. Do not look directly into the LED lights of the drone as it can damage your eyes.
17. Open the battery cover of the toy with screwdriver.
18. The packing has to be kept since it contains important information.
19. Do not touch the rotating rotor, avoid loose clothing or hair that could be caught in the rotor, do not fly near the face.
20. Advice to keep the instructions for use.

Repair and maintenance

1. Use clean and soft cloth to clean the product.
2. Keep away the product from heat sources.
3. Avoid water exposure to this product. Moisture may cause damages of the aircraft electronic parts.
4. Transformers used with the aircraft should be examined regularly, such as the cord, plug, enclosure and other parts. In case of any damages is found, please stop using it unless it is repaired or replaced.

Box Contents

- Drone
- Transmitter
- User Manual
- Blades
- USB Charger
- Li - PO Battery

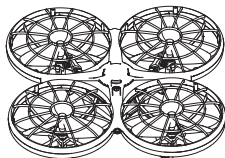

Repair and maintenance

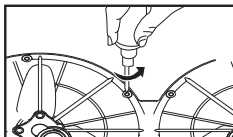

Step 1: Remove all screws

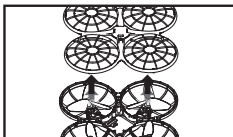

Step 2: Disassemble top body

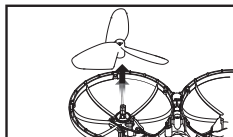

Step 3: Remove screws the Blade can be removed

Changing and Charging the Drone's Batteries Protective Guards

Replacement battery steps;

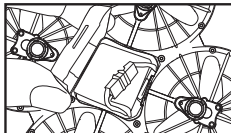

1. Make sure drone is in a closed state, then open battery cover

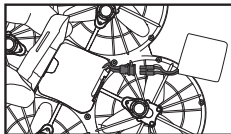

2. Disconnect the battery plug and remove the battery

Charge battery method:

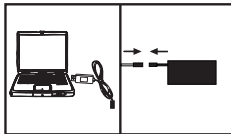

3. Connect the USB port to your computer's USB and connect the battery power cord to the USB. (The indicator light is on when charging, full the power indicator is off.)

Charging time is about 90 minutes.

Important: battery charging information.

- Do not keep the battery in high temperature areas, such as fire or heat sources. Otherwise, it may damage the battery or even trigger an explosion.
- Do not put the battery into water. Store the battery in a cool and dry environment.
- Avoid dismantling the batteries.
- During the charging of battery, avoid leaving the charging place.
- Rechargeable batteries should be removed from the toy before being charged.
- Rechargeable batteries should only be charged under the supervision of adults.
- Exhausted batteries should be removed from the aircraft.
- Caution: Risk of explosion if battery is replaced with incorrect ones, Please dispose the batteries according to the instructions.

Understanding the Transmitter

Transmitter functions:

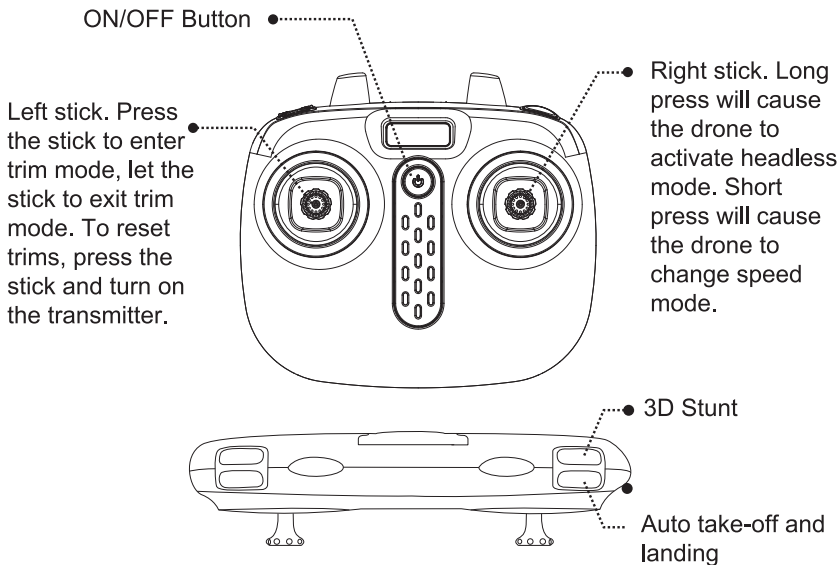

Understanding the Transmitter

Installing transmitter batteries:

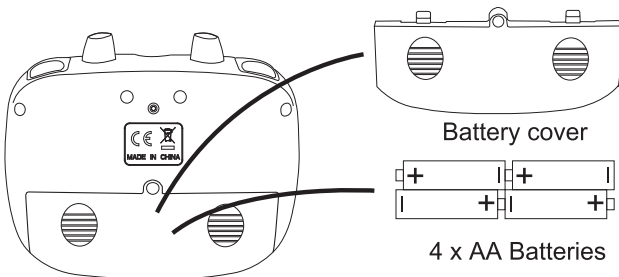

Transmitter battery installation: open the battery cover at the back of the transmitter. Install 4pcs AA batteries according to the polarity indications (Note: batteries are not included).



1. During the battery installation, it must be ensured that the polarities of the batteries are matched with that of the battery box. No battery shall be installed with the opposite polarity.
2. Please do not use new and old batteries together.
3. Please do not use different types of batteries together.
4. Do not use rechargeable batteries.

Preparation for Flight

1. Flight preparation

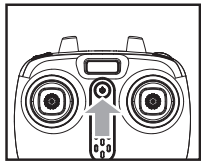

Step1: Turn on the transmitter.

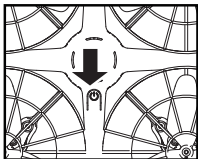

Step2 :Turn on the drone

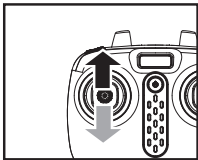

Step 3: Move the left stick (throttle) fully up and after fully down. The drone indicator lights will turn solid (glow) indicating the drone is ready to fly.

Preparation for Flight

2.Arming Motors

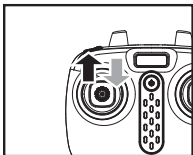

Method 1:

Move the left stick (throttle) fully up, after let it come back to the middle and the motors will start spinning.

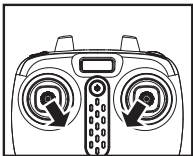

Method 2:

Push both sticks at the same time (left stick to the bottom-right corner and the right stick to the bottom-left corner) and hold for 1 second and the motors will start spinning.

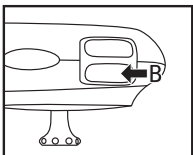

Method 3:

Place the drone on a flat level surface and after press the B button. The drone will take-off, and hover at the preset height.the motors will start spinning.

1. If the drone flies out of control range, the drone indicator lights will start flashing slowly and after the drone will slowly descend.
2. If the transmitter turns off or the transmitter battery runs low, the drone will slowly descend. Turn on the transmitter again, re-pair the unit and continue to fly.

3. Disarming Motors

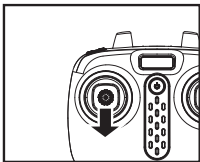

Method 1:

Push the left stick (throttle) fully down and hold it there for 2-3 seconds and the motors will stop spinning.

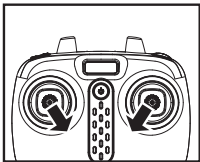

Method 2:

Push both sticks at the same time (left stick to the bottom-right corner and the right stick to the bottom-left corner) and hold for 1 second and the motors will stop spinning.

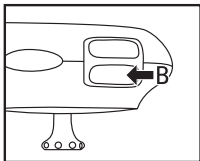

Method 3:

After the drone is in stable hovering position, press the B button and the drone will slowly land. Motors will be automatically disarmed.

Fly the Drone

Operations

Ascend/Descend

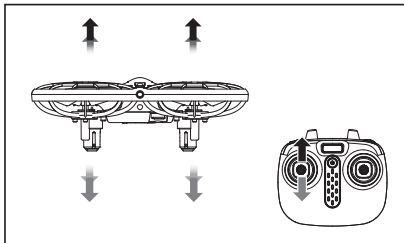

When the left stick (throttle) is moved up / down, the drone will ascend / descend.

Forward/Backward

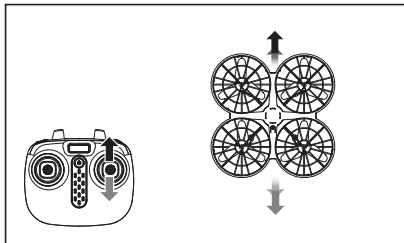

When the right stick is moved up / down the drone will fly forward / backward.

Left/Right Rotation

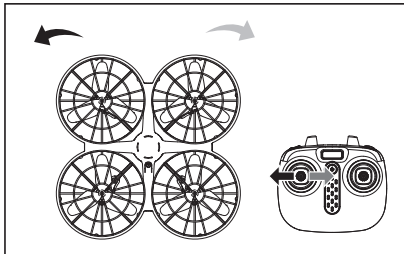

When the left stick (throttle) is moved left / right the drone will rotate to the left / right.

Left/right

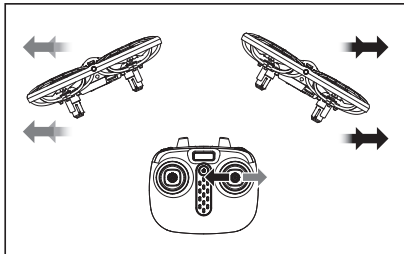

When the right stick is moved left / right the drone will fly to the left / right.

Forward/Backward Trim Control

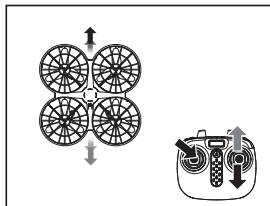

If the drone drifts quickly forward or backward while hovering, please adjust forward/backward trim. Press the left stick and hold it, then move the right stick forward / backward until the drone starts hovering as normal.

Left/Right Trim Control

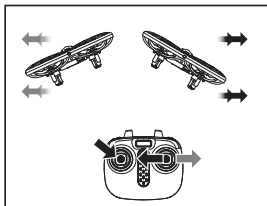

If the drone drifts quickly to the left/right while hovering, please adjust left/right trim. Press the left stick and hold it, after move the right stick to the left/right until the drone starts hovering as normal.

Left/Right Rotation Trim Control

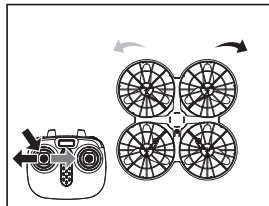

If the drone automatically rotates and flies towards the left/right side while hovering, press in the left joystick and at the same time move it to the right/left slightly to fine tune the direction. Don't release the left joystick until the drone is flying in a stable state.

Product Features

1. Low-Voltage Protection:

When the drone battery voltage is low, the drone indicator lights will start flashing. After this warning, return your drone to the desired place and land it.

2. OverflowProtection:

When the drone is in the air and the propellers collide with objects or become jammed, the drone overflow protection will be activated.and land it.

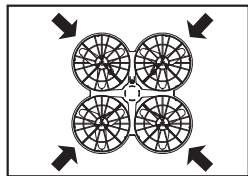

3. Balance Calibration:

Place the drone on a flat level surface and after, push both sticks to the lowest right corners and hold them there for 2 to 3 seconds. The drone indicator lights will start flashing quickly. Wait until the drone indicator lights stop flashing and turn solid again (glow) indicating successful balance calibration.



4. Low/High Speed Mode:

Low speed mode is the default mode. To change the speed mode gently press the right stick once, the transmitter will emit two beeps indicating high speed mode. Gently press the right stick again and the transmitter will emit one beep indicating low speed mode.



5. 3D Stunts:

After the basic operational skills are mastered, you can start performing 3D stunts with high speed mode, After reaching a certain height. Press the 3D stunt button (top right button on the transmitter) and at the same time push the directional stick completely forward / backward / left / right. The drone will perform forward/backward/left/right 3D stunt.

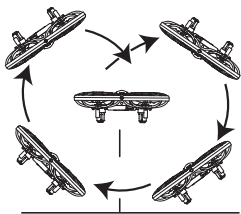

Notice: Fully charged drone battery will ensure the best 3D stunts performance.

6. Obstacle avoidance function:

Obstacle avoidance conditions and requirements:

- a. The drone must be in the slow mode to achieve the obstacle avoidance function.
- b. You must avoid using the function outdoors or infra-red interference, such as poor obstacle avoidance under strong sunlight or infrared light or even loss of obstacle avoidance.
- c. In the face of glass objects or dark objects, the drone has poor obstacle avoidance effect and even loses the obstacle avoidance function. The obstacle avoidance effect in front of light objects can be better reflected.
- d. If the drone is flying close to the ceiling, the drone will lose control.

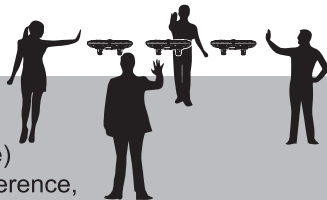

Note:

1. White objects are best. (There is no obstacle avoidance function in high speed mode)
2. In order to avoid malfunction of infrared interference, please do not operate two aircraft at the same time within 5 meters.

7. Height Hold:

Use the left stick (throttle) to achieve the desired height and after allow the left stick to fall back to its default middle position.

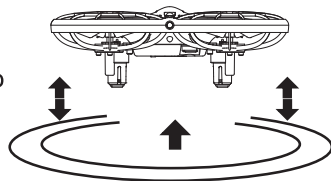

8. Headless Mode:

①. Setting Forward Direction

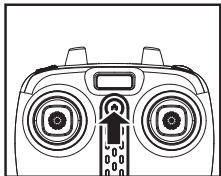

1. Turn on the transmitter.

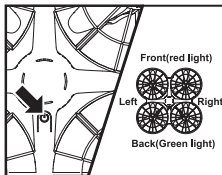

2. Turn on the drone and after position the drone with it's front facing forward direction.

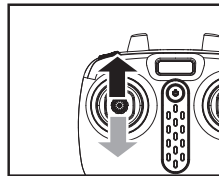

3. Move the left stick (throttle) fully up and after fully down. The transmitter will emit one long beep indicating successful pairing and defined forward direction.

②. Calibration



When in headless mode, the forward direction may start deviating due to numerous crashes. Re-set the forward direction and after push both sticks simultaneously to the lowest left corners. The drone indicator lights will start flashing and after 3 seconds will turn solid (glow) indicating successful calibration.

③. Activating/Deactivating Headless Mode:

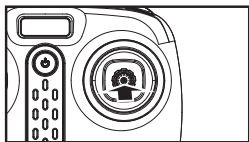

After successful pairing observe the drone indicator lights and wait until they turn solid (glow). Press the right stick and hold it for 2 seconds, the transmitter will emit 3 beeps indicating headless mode is activated. Press the right stick again and hold it for 2 seconds after the transmitter will emit one long beep indicating headless mode is deactivated.

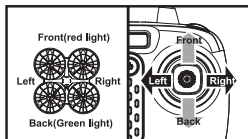

When flying in the headless mode, it does not matter in which direction the front of the drone is facing. It will fly forward/backward/right/left relative to the position of pilot.

Warning: Changes or modifications to this unit not expressly approved by the party responsible for compliance could void the user's authority to operate the equipment.

NOTE: This equipment has been tested and found to comply with the limits for a Class B digital device, pursuant to Part 15 of the FCC Rules.

These limits are designed to provide reasonable protection against harmful interference in a residential installation.

This equipment generates, uses and can radiate radio frequency energy and, if not installed and used in accordance with the instructions, may cause harmful interference to radiocommunications

However, there is no guarantee that interference will not occur in a particular installation. If this equipment does cause harmful interference to radio or television reception, which can be determined by turning the equipment off and on, the user is encouraged to try to correct the interference by one or more of the following measures:

- Reorient or relocate the receiving antenna.
- Increase the separation between the equipment and receiver.
- Connect the equipment into an outlet on a circuit different from that to which the receiver is connected.
- Consult the dealer or an experienced radio/TV technician for help.

“This device complies with FCC radiation exposure limits set forth for general population (uncontrolled exposure).

This device must not be collocated or operating in conjunction with any other antenna or transmitter.”

RF frequency band :2408-2478MHZ

Transmitter power : -3.73dBm (Max.)

product name: [Drone for kids]

model number: [X26]

Brand name :Loolinn

Accessories /Parts (Optional)

Please, look through the parts below. For your convenience, we have specified every part and accessory. The parts and accessories can be purchased through local distributors. Please specify desired colours at the time of purchase.

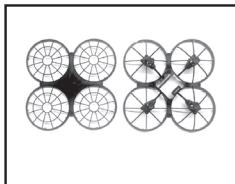

Body



Main Frame

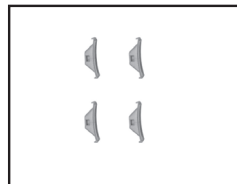

LED Light
Protective Cover



Blade A



Blade B



Battery cover

Accessories /Parts (Optional)

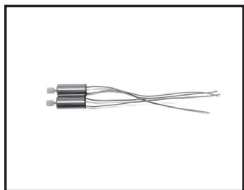

Motor A

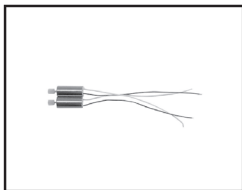

Motor B



Battery



Circuit Board



USB Charger

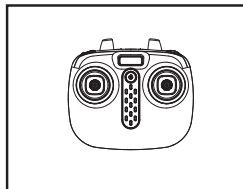

Remote Control

Product Main Parts and Components

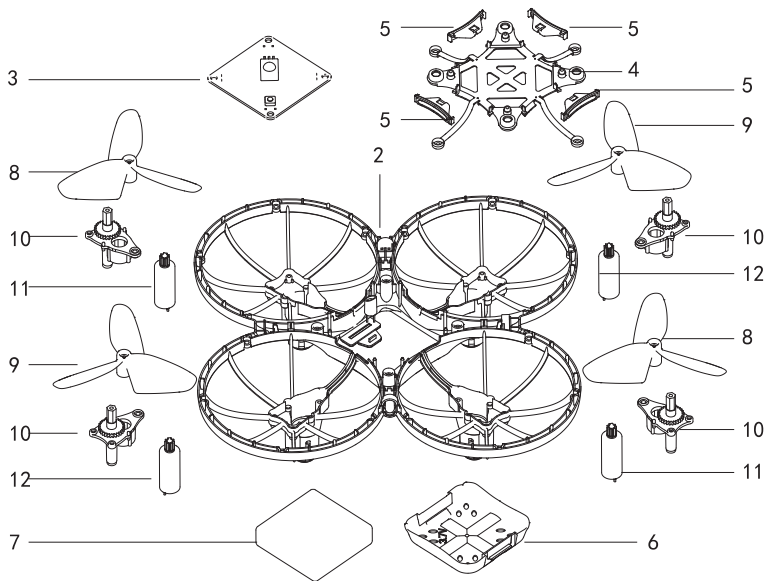

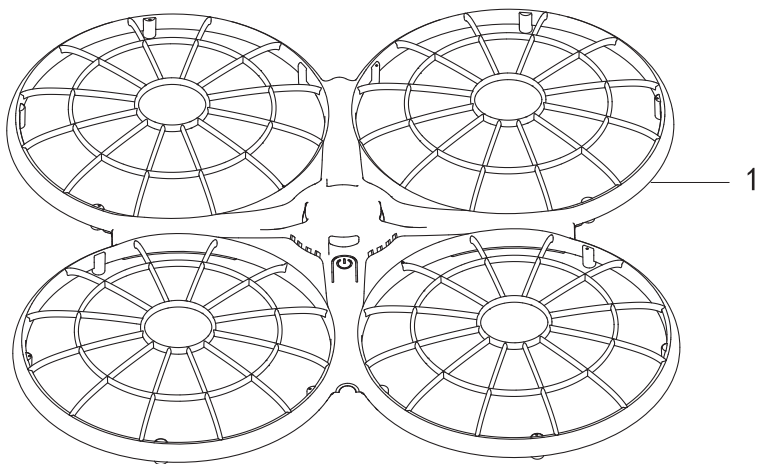

Serial number	Component/ Part Name	Quantity	Serial number	Component/ Part Name	Quantity	Serial number	Component/ Part Name	Quantity
01	Top Main Body	1	05	LED Light Protective Cover	4	09	Blades B	2
02	Bottom Main Body	1	06	Battery cover	1	10	Main Frame	4
03	Circuit Board	1	07	Battery	1	11	Motor A	2
04	bulkhead	1	08	Blades A	2	12	Motor B	2

Main Specifications

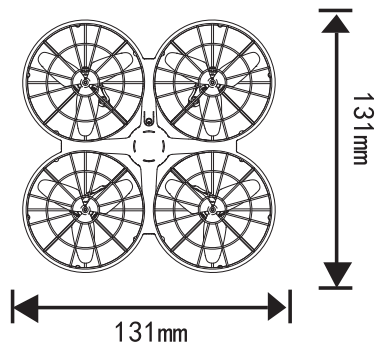
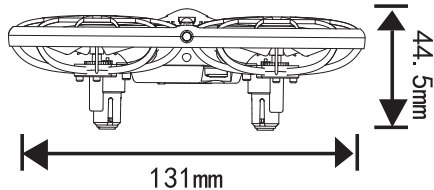

Drone length: 131 mm
Drone width: 131 mm
Drone height: 44.5 mm

Motor Size: $\varnothing 7$

TroubleShooting

Problem	Reason	Solution
The drone does not respond.	<ol style="list-style-type: none"> 1.The drone has activated low-voltage battery protection. 2.The transmitter's battery is low, the transmitter indicator light flashes. 	<ol style="list-style-type: none"> 1.Recharge the drone's battery. 2.Change the transmitter's battery.
The transmitter sticks are not sensitive.	<ol style="list-style-type: none"> 1.The transmitter battery is low. 2.There is another transmitter with the same frequency causing 	<ol style="list-style-type: none"> 1.Change the transmitter's battery. 2.Please change flying location.
The drone is unstable when hovering or quickly drifts in one direction.	Balance calibration is needed.	Perform balance calibration. Please relate to page number 12.
When in headless mode the forward direction deviates.	Numerous crashes.	Re-set forward direction. Please relate to page number 14.
The drone does not hold the set altitude.	<ol style="list-style-type: none"> 1.Balance calibration is needed. 2.Flying the drone in severe weather. 3.Heavy crash impacts gyroscope calculations. 	<ol style="list-style-type: none"> 1.Perform balance calibration. Please relate to page number12. 2. Avoid flying the drone in severe weather conditions (strong wind, rain, snow, fog, thunder etc.) 3.Perform balance calibration. Please relate to page number 12.location.

