

Loolinn®

14+
for age

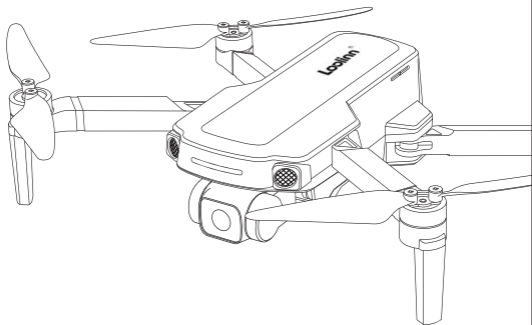

F5 FOLDING DRONE PRO

— ULTRAPORTABLE AND FOLDABLE —

In order to make sure that it meets the requirement of the electromagnetic environment of the aviation radio station, flying within the scope of 10 kilometers on each side by taking the airport runway center line as the middle line is **HIGHLY FORBIDDEN** or flying within the scope of 20 kilometers by taking both ends of the runway as the center is **HIGHLY FORBIDDEN**. Flying on the route of the airline is also **PROHIBITED**. Stop using all kinds of flying models or unmanned Quad-rotors in the **AREA** that prohibited by related authority or department of our country.

CATALOGUE

English ----- 01~27

Deutsch -----28~54

Français ----- 55~ 81

Italiano ----- 82 ~ 108

Español ----- 109 ~ 135

CONTENTS

PREFACE	1
WARNING	3
EXEMPTION	5
FLY SAFETY	6
AIRCRAFT	7
1. AIRCRAFT DIAGRAM	7
2. ASSEMBLE THE PROPELLER	7
3. INTELLIGENT FLIGHT BATTERY	8
REMOTE CONTROL	8
1. REMOTE CONTROL FUNCTIONS	8
2. REMOTE CONTROL OPERATING METHOD	9
3. DUAL REMOTE CONTROLLER MODE	9
LITHIUM BATTERY	10
1. CHARGE THE BATTERY	10
2. LITHIUM BATTERY CHARGING INSTRUCTIONS	10
FLIGHT	11
Loolinn Pro APP	14
1. DOWNLOAD THE Loolinn Pro APP	14
2. APP INTRODUCTION	14
ONE-KEY FLY FAR	15
ONE-KEY SKYROCKETING	15
ONE-KEY SPIRAL	15
VERTICAL-SCREEN AERIAL PHOTOGRAPH	16
TIME-LAPSE PHOTOGRAPHY	16
PANORAMIC SHOOTING	16
3. APP ONE KEY SHARE FUNCTION	16
4. HOW TO SEARCH THE LOST DRONE	17
5. FLIGHT	17
6. SAVE THE PHOTO AND VIDEO TO THE MOBILE APP ALBUM	18
AIRCRAFT FUNCTION PROFILE	19
1. WAY POINT FLIGHT	19
2. POINT OF INTEREST	19
3. EMERGENCY STOP	20
4. GPS FOLLOW-ME	20
5. IMAGE RECOGNITION FOLLOW ME/GESTURE CONTROL	21
6. HAND GESTURE	21
7. RETURN-TO-HOME (RTH)	21
8. OPTICAL FLOW VISION SYSTEM	22
9. CAMERA FUNCTIONS	23
COMMON SOLUTIONS	24
SPECIFICATIONS	25
PARTS LIST (INCLUDED)	26
COMMON PROBLEMS AND SOLUTIONS	27

PREFACE

Thank you for purchasing the Loolinn-Series GPS aircraft. Please read all instructions and warnings carefully before operating. Please also keep this instruction manual for future reference and maintenance.

IMPORTANT:

1. This product should be operated by the people who are over 14 years old. It is a precision device; integrating machinery and electronics with air mechanics and high frequency transmission. It requires correct assembly and debugging to avoid any accident. The user should operate and control this product in a safe manner. In case of incorrect operation, it may cause serious injury or damage property. It can also be lost due to incorrect operation.
2. This product is suitable for experienced UAV pilots no less than 14 years of age.
3. In the event of a problem during using, operating, or maintenance, Please contact Loolinn customer service to solve (**Our email:LooLinn123@gmail.com**)

SAFETY PRECAUTIONS:

This R/C aircraft can be dangerous when in use, please make sure you keep it far away from any persons or spectators when flying. In-correct installation, poor conditions, or users not familiar with operation may cause damage to the aircraft or injure people or may cause an unexpected accident. Please pay close attention to flying safety and learn to recognize more dangerous conditions which may cause an accident due to your own negligence.

1. Keep it far away from any structures or crowds.

This R/C aircraft may vary slightly in speed or sensitivity while flying and can cause potential danger. Therefore, please keep it far away from crowds, buildings, trees, structures, high-voltage wire, etc. Please also avoid flying in adverse weather conditions such as rain, electrical storms, and high winds to ensure safety of the user, any spectators, and surrounding property.

2. Keep it away from any moist environment.

The inside of the aircraft is composed of many precision electronic and mechanical parts. Therefore, please try to avoid any moisture or water content from entering the main body of the aircraft as it may cause a breakdown of the mechanical and electronic parts and thus cause an accident.

3. Only operate with included parts for intended use.

Please use the original parts made by Loolinn-Series for any re-equipping or maintenance to ensure flying safety. Please operate and use only under the scope of the product function permitted. Using un-approved parts will void warranty.

DO NOT use for any illegal purpose or use beyond the scope of which your local laws and regulations have stipulated.

4. Avoid controlling it independently.

New users may have certain difficulties during the early stages of learning to operate this aircraft. Please try to avoid operating the aircraft alone. When available, always operate this aircraft under the guidance of a more experienced user.

5. Do not operate under the influence of drugs or alcohol.

Please operate this R/C aircraft according to your own state and flying skill. Any fatigue, bad mental state, or incorrect operation may increase the probability of accidental risk.

6. Please keep a safe range from aircraft when using top speed.

When the operator is flying in high speed, please keep the aircraft far from the pilot and any surrounding persons or objects so as not to cause danger or damage.

7. Store it in a cool, dry place.

The R/C aircraft is composed of material such as metal, fiber, plastic, electronics, etc. Therefore, please keep it away from any heat source and avoid prolonged exposure to direct sunlight. Excessive heat exposure can cause distortion and damage.

- NOTE: This equipment has been tested and found to comply with the limits for a Class B digital device, pursuant to part 15 of the FCC Rules. These limits are designed to provide reasonable protection against harmful interference in a residential installation. This equipment generates, uses and can radiate radio frequency energy and, if not installed and used in accordance with the instructions, may cause harmful interference to radio communications.
- However, there is no guarantee that interference will not occur in a particular installation. If this equipment does cause harmful interference to radio or television reception, which can be determined by turning the equipment off and on, the user is encouraged to try to correct the interference by one or more of the following measures:
 - Reorient or relocate the receiving antenna.
 - Increase the separation between the equipment and receiver.
 - Connect the equipment into an outlet on a circuit different from that to which the receiver is connected.
 - Consult the dealer or an experienced radio/TV technician for help.
- Please note that changes or modifications not expressly approved by the party responsible for compliance could void the user's authority to operate the equipment.

WARNING

1. There is important information contained in this package and instruction manual, please keep it for future reference.
2. You have the responsibility to make sure that this model of aircraft won't cause injury to others' body or cause any damage to property.
3. Please operate strictly as shown on the instruction manual when debugging or assembling this aircraft. During the process of flying or landing, please pay more attention to keep 1-2 meters between the user and the aircraft to avoid colliding to the head or face or body, which may cause injury.
4. Our company and distributors won't be responsible for any incorrect operation, which may cause loss or damage or injury to the body.
5. The product should only be used by adults and children 14 years and older. Adult supervision is required for children under 14 years of age.
6. Please correctly assemble and use this product as shown on the instruction manual or packing instruction. Some parts should be assembled by an adult.
7. Small parts are included with this product. Please place it beyond the reach of the children to avoid a CHOKING HAZARD or parts being mistakenly swallowed.
8. Playing on the road or near high traffic areas is strictly FORBIDDEN so as not to cause an accident.
9. Please dispose of the packing material timely so as not to cause injury to children.
10. Please DO NOT disassemble or re-equip the aircraft as it may cause a breakdown of the aircraft during flying.
11. Batteries in the battery compartment of the charger should be inserted into the designated power source which has the same logo as the product.
12. Built-in rechargeable 3.7V lithium polymer battery included in the remote control.
13. Only the original charger made from our factory can be used.
14. Charger is not a toy.
15. When charging the battery, please conduct it under the surveillance of an adult. Please also keep it far away from any combustible object when charging. Please keep this aircraft within eyesight when charging.
16. Please DO NOT make it short-circuited or squeeze the battery so as not to cause an explosion.
17. DO NOT mix the Li-ion battery with a different type of battery.
18. Intelligent lithium battery is loaded in the Quad-rotor. Both built-in or external can be used for charging.
19. Please DO NOT make the battery short-circuited or decompose the battery or throw the battery into the fire; DO NOT place the batteries near the high temperature or heated area (such as near the fire or near the electric heating device).

20. The aircraft should be kept far away from any other electric compliance or equipment as far as possible or kept far away from the place where having the magnetic object nearby as they may cause interference with each other.
21. Please keep the safe distance from the high-speed rotating rotor so as not to cause twisted or danger of being wounded or being cut.
22. Engine will heat up. Please DO NOT touch it to avoid being burned or injured.
23. Please DO NOT close this product to your ear as it may cause injury to your hearing.
24. Type-C5V wall charger recommended for charging. DO NOT use any charger stronger than 5V.
25. To comply with the command of the magnetic environment requirement formulated by the Aviation Radio Bureau and the related authority, during the regulated period in certain areas, please stop using the remote control of this model when such regulation command is issued.
26. Keep your UAS within sight.
27. Never fly over groups of people.
28. Never fly over stadiums or sports events.
29. Understand airspace restrictions and requirements.



WARNING: Product should only be used by adults and children 14 years and older. Adult supervision required for children under 14 years of age.

WARNING: CHARGING OF THE AIRCRAFT BATTERY MUST BE SUPERVISED AT ALL TIMES BY AN ADULT. UNPLUG THE BATTERY WHEN FULLY CHARGED. DO NOT OVER-CHARGE THE BATTERY.

EXEMPTION

When using this product, Loolinn shall not be responsible for direct or indirect damages caused by the following reasons:

1. The damage caused by the user in the condition of drinking, drug taking, drug anesthesia, dizziness, fatigue, nausea and other poor physical or mental conditions.
2. Personal injury, property loss and legal liability caused by the user's subjective intention or wrong judgment.
3. Compensation for any related spiritual damage caused by the accident.
4. Damage caused by users flying in flight areas prohibited by laws and regulations such as nature reserves.
5. Other damage caused by poor operation of Quadrotor due to re-equipment training or replacement of accessories or parts not produced by Loolinn.
6. The Quadrotor sends low-pressure alarm and still does not land, resulting in the Quadrotor falling down.
7. Damage caused by forced flight knowing that the Quadrotor is in an abnormal state (such as water, oil, soil, sand or other unknown substances mixed in or the assembly is not completed or the main components have obvious faults or the accessories have obvious defects or missing).
8. Damage caused by the Quadrotor flying in magnetic interference area, radio interference area (such as areas near high-voltage power lines, large power equipment, radio and television transmission towers, mobile phone base stations, etc.), no fly area specified by the government, or the user's vision is in backlight, blocked by obstacles, blurred vision, poor vision and other conditions unsuitable for control.
9. Fly in bad weather, such as rain or wind (more than level 4), snow, hail or other bad weather.
10. The Quadrotor encounters collision, overturn, fire, explosion, lightning strike, storm, tornado, rainstorm, flood, tsunami, ground subsidence, ice subsidence, cliff collapse, avalanche, hail, debris flow, landslide, earthquake, etc.
11. Damage caused by infringement of any data, audio or video data obtained by the user using the Quadrotor.
12. For the battery, such as damage caused by improper matching of protection circuit, battery pack and charger.
13. Any indirect losses or legal liabilities caused by problems of equipment or accessories (including memory cards), for example, images or videos that cannot be saved.
14. Losses or legal liabilities caused by the user's reckless unsafe flight without completing sufficient flight training.
15. The user promises to use the product only for legitimate purposes and agrees to abide by these terms and any relevant policies or guidelines that may be formulated by Loolinn. Some details of this document may change with the upgrade of the product software version. Please read the upgrade details carefully before upgrading the software version. The instruction manual will be updated with or without prior notice.

FLY SAFETY

WiFi transmission area requirements:

1. Make sure fly in the open area without any interference and obstacle.
2. Do not fly against the wind.



+



+



+



Fly in Open Areas

Strong GPS Signal

Maintain Line of Sight

Maximum flight altitude height is about 120 meters.



Avoid flying over or near obstacles, crowds, high voltage power lines, trees, airport or bodies of water.

DO NOT fly near strong electromagnetic sources such as power lines and base stations as it may affect the onboard compass.



DO NOT use the drone in adverse weather conditions such as rain, snow, fog and wind speeds exceeding 5 m/s or 12 mph.

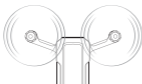

No Fly Zone

Stay away from the rotating propellers and motors.



It's important to understand basic flight guidelines, for the safety of both you and those around you. Don't forget to read the Safety Guidelines before flight.

AIRCRAFT

1. AIRCRAFT DIAGRAM

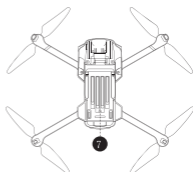
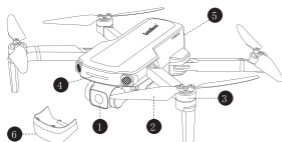

1. HD Camera
2. Propeller
3. Motor
4. LED indicator
5. Intelligent battery
6. Gimbal cover buckle
7. Optical flow sensor

2. ASSEMBLE THE PROPELLER

Please note that the letter "A" or "B" is printed on each propeller, and make sure all the propellers are attached in the correct motor position.

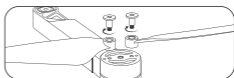
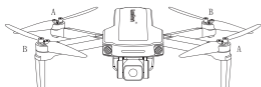

3. INTELLIGENT FLIGHT BATTERY

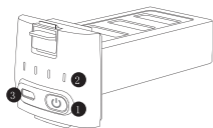

1. Battery switch
2. Battery power indicator
3. Type-C charging port

Low — Electricity — High



—Hold the switch button for 3 sec. power on; then press the button for 3 sec. power off.

—When the battery in low voltage, blue indicators will be blinking, now please charge the battery.

Note: the battery is equipped with an automatic discharge function after fully charged. After charging the battery, if it is not used in a high-temperature environment for a long time, in order to prevent the battery from being damaged, the battery will automatically discharge to 8V and then stop discharging. (Note: the battery is 8.8V after charging)

REMOTE CONTROL

1. REMOTE CONTROL FUNCTIONS

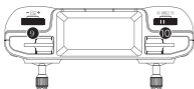

1. Throttle stick
2. Direction stick
3. Click once then keep pressing for 2 seconds to emergency stop
4. Click once to check the electric quantity; then keep pressing for 3 seconds to power on
5. Click once speed switch; keep pressing for 3 seconds to enter the altitude mode
6. Click once to RTH mode
7. Click the button to take photo
8. Click the button to take video
9. Zoom in and out
10. Adjust the angel of camera up and down

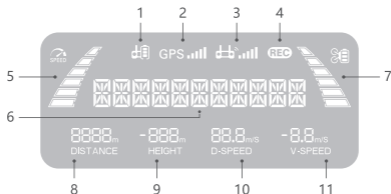

- | | |
|--|----------------------------------|
| 1. Electric quantity of remote control | 7. Electric quantity of aircraft |
| 2. GPS signal intensity | 8. Distance |
| 3. Remote control signal intensity | 9. Height |
| 4. Photo/video | 10. Flight speed |
| 5. Speed | 11. Ascend/Descend speed |
| 6. Status Display | |

Tips: When the remote control is in low power,  keeps flashing, now you need to charge the remote control.

2. REMOTE CONTROL OPERATING METHOD

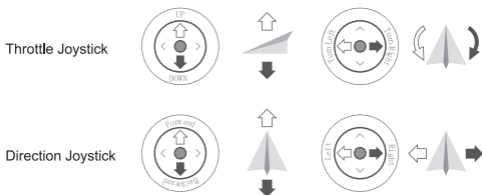

3. DUAL REMOTE CONTROLLER MODE



—Power off the remote control.

—Keep pressing the and clicking the twice at the same time. (Click once to check the electric quantity; then keep pressing for 3 seconds to power on) Now the right joystick is the throttle stick. LCD screen appears "R HRMD MODE", now the right joystick turns to throttle operating mode. Turn off the remote control and turn it on again, now the left joystick turns to throttle operating mode.

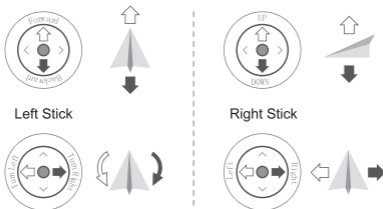

LITHIUM BATTERY

1. CHARGE THE BATTERY

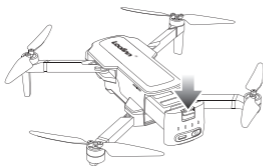

Press the buckle and take out the battery from the aircraft.

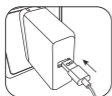

Phone adapter:
5V= 2A
(Not included)



Charging time:
About 3 hours
(Depending on
Charging adapter)



Remote control
charging method

2. LITHIUM BATTERY CHARGING INSTRUCTIONS

1. Either power on or power off, the aircraft can be charged. Connect the Type-C charger to an DC power supply (4.5V-5.5V, 2A-3A), and then connect with the charging port of the aircraft, when in charging, the indicator on the aircraft will become Blue blinking; All indicators keep solid on means charging completed.
2. Aircraft can be charged by the mobile power or car-loaded power.
3. Charging time of aircraft takes about 3 hours; operating time takes about 20 min.
4. Remote control is built-in 3.7V 300 mAh lithium polymer battery, charging time takes about 30 min, operating time about 1.5 hours.

(When in charging, the indicator on the remote control become Red; when fully charged, the indicator on the remote control will turn to solid Green).

FLIGHT

Step 1: Turn on the drone and set down on a level surface

- Switch on the aircraft, blue light (front) + blue light (rear) keep flashing quickly.
- Place the aircraft on the level surface and it will enter into frequency matching automatically and the red indicator at the bottom of the aircraft will appear flashing slowly.



Step 2: The remote control and aircraft successfully match frequency automatically.

- Switch on the remote control (Click once to check the electric quantity; then keep pressing for 3 seconds to power on).
- Now the remote control successfully matched and the LCD shows "GPS MODE" while the front and rear blue light will be slowly flashing alternately.
- NOTE:You connect to the WIFI at this time to view the current drone on the Loolinn Pro App, or wait until after GPS is calibrated.

Step 3: Connect APP

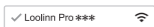

- Connect your mobile device to the WIFI of aircraft and check the aircraft's status on the "Loolinn Pro *** APP.

Step 4: Compass Calibration

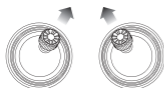

- Push the joysticks into the 1 & 11 o'clock position.
- Blue light(rear)+red light and blue light(front) will be flashing quickly.
- App aircraft status: "Compass calibration".

Remark: The compass will be calibrated automatically when the magnetic interference occur, it is necessary to calibrate the compass manually.

Step 5: Compass Calibration—Part 1

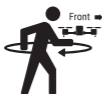

- Pick up the aircraft horizontally and turn it around with your body (360°).
Now remote control makes "DI" sound.
- Blue light + red light at the bottom of the aircraft—Solid on.

Step 6: Compass Calibration—Part 2



- Pick up the aircraft from the bottom, head of the aircraft facing down and follow your body for a complete circle (360°).
Now remote control makes "DI" sound.
- Blue light (front and rear) of the aircraft—Flashing slowly.

APP Status: Please place the aircraft on a level ground and hold the aircraft stationary until the head of the pendant recallocates.

Step 7: GPS Searching (DO NOT use GPS Mode indoor)



- Reposition the aircraft on a horizontal surface.
- Blue light (rear) + blue light (front) of the aircraft keep slowly flashing. It means the GPS enters into the state of Satellite Search
- It takes a few minutes to complete this step
- Status displayed on APP: Waiting for GPS signal.
- Blue light (rear) + blue light (front) of the aircraft shows Solid on, this means the GPS satellite searching is successful.

NOTICE: Fly in open areas, tall structures and large metal structures may affect the accuracy of the onboard compass and GPS system. Please search the GPS signal in the open areas.

Step 8: Calibrate Gyroscope



- Push the joysticks into the 11 & 1 o'clock position.
- Blue light (rear) + Blue light (front) of the aircraft: Keep flashing quickly.
- App Drone Status: "Gyroscope calibrated".

Step 9: Reset to factory Setting / Level calibration

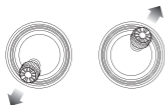

- Push the throttle stick of the remote control to the "7" o'clock position and push the direction stick to the "1" o'clock position.
- Blue light (rear) + White light (front) of the aircraft: Keep flashing quickly.
- App Status: 'Reset to factory Setting/Level calibration'.

Precautions: Please put the aircraft on the horizontal ground for the restore factory setting. Otherwise it may affect the flight attitude.

Step 10: Starting/Stopping motors

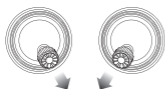

- Push the joysticks into 5 & 7 o'clock position
 - Motors automatically to start, push the left joystick to take off the aircraft. (Starting the motors before the aircraft taking off).
- NOTE: Starting the motors should be set before the aircraft take off.

—Stopping Motors:

1. Pushing the joysticks into 5 & 7 o'clock position again, motors stop working.
2. The motors will stop working if the motors starting are not operated after 20 seconds.

Once all the lights on the aircraft are Solid on, now the aircraft can be took off.

- Blue light (rear) + blue light (front): Solid on.
- App aircraft status: "Ready to fly".

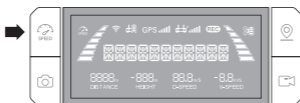

NOTICE: If the LED indicators on the arms of the aircraft: blue light (rear) + blue light (front) keep slowly flashing means the GPS signal is weak; Please keep pressing  for 3 seconds to turn off the GPS mode: blue light (rear) keeps flashing + blue light (front) is solid on, aircraft enter into the flight altitude mode, now the aircraft can take off.

LOOLINN PRO APP

1. DOWNLOAD THE Loolinn Pro APP

QR code of "Loolinn Pro" software for Apple IOS system.

QR code of "Loolinn Pro" software for Android system



- Connect the power of this model, and then access into "SETTING" in the smart phone, open the "WIFI" and find the "Loolinn-Pro *** -BRG"
When the link is successfully connected, please exit the "Setting" option.
- Open "Loolinn Pro" software in the smart phone to access into the control interface.

2. APP INTRODUCTION

Wait until the aircraft Status says "Ready to Fly" before initiating flight.

This will ensure that your GPS is synced and your aircraft is ready to fly.



- | | | |
|-------------------------|-----------------------|------------------------|
| 1. Back to Main Menu | 7. Auto Take-off | 13. Media Gallery |
| 2. Compass interference | 8. GPS Return Home | 14. Sound Recording |
| 3. Remote Battery | 9. More Functions | 15. Distance (meters) |
| 4. GPS Signal | 10. SD card status | 16. Height (meters) |
| 5. Aircraft Battery | 11. Shooting Function | 17. Speed (meters/sec) |
| 6. Setting | 12. Shutter | |

🔗 One-key fly far

1. Keep the distance between the aircraft and the target is more than 2 meters,adjust the lens manually to aim at the target.
2. Click the One-key far fly icon in the APP and slide to confirm.
3. Click the One-key far fly icon in the APP again or pull the direction lever on the remote control to exit the far-fly function.

Remark: When starting the flight, the aircraft will move back about 25 meters away from the target and start the video shooting function at the same time. The aircraft will automatically return to the take-off point after performing the completion function. Pull the direction lever to exit. Pay attention to the backward direction of the aircraft. Make sure there are no obstacles or crowds nearby so as to avoid any injury. In case of emergency, please pull the direction lever on the remote control immediately to stop the flight!

📈 One-key Skyrocketing

1. Keep the distance of the aircraft with the target below more than 2 meters,then adjust the lens manually to aim at the target.
2. Click the One-key skyrocketing icon in the APP ,and slide to confirm.
3. Click the One-key skyrocketing icon in the APP again or pull the direction lever on the remote control to exit the Skyrocketing function.

Remark: When starting the flight, the aircraft will automatically rise about 15 meters height and start the video recording at the same time. The aircraft will automatically return back to the take off point after performing the completion function. Pull the steering lever to exit. Make sure there no obstacles above the aircraft so as to avoid any injury. In case of emergency, please immediately pull the direction lever of the remote control to stop the flight!

🌀 One-key Spiral

1. Keep the distance between the aircraft and the target at about 2 to 5 meters and manually adjust the lens to aim at the target.
2. Click the One-key spiral icon in the APP,and slide to confirm.
3. Click the One-key spiral icon in the APP again or pull the direction lever on the remote control to exit the spiral function.

Remark: When starting the flight, the aircraft will automatically spiral up (with a maximum radius of about 15 meters) and start the video shooting function at the same time. The aircraft will automatically return to the take off point after performing the completion functions. Push the direction lever to exit. Make sure there are no obstacles or people around the aircraft so as to avoid any injury. In case of emergency, please immediately pull the direction lever on the remote control to stop the flight!

Vertical-screen Aerial Photograph

Click the Vertical-screen Aerial Photograph icon in the "Shooting Function" on the right side of the preview page of the APP and the mobile screen will appear vertical screen.

Time-lapse Photography



1. Click the APP function page, Shooting Function--Time-lapse Photography
2. Slide to select the Delay Magnification and click OK.
3. Click the ● to start time-lapse photography.
4. Click the ● again to finish shooting.

Panoramic Shooting

1. Click the APP function page and select the  .
2. Click the ●
3. The aircraft rotates about one circle (360°) to complete panoramic shooting, automatically synthesize a panoramic picture, and save it in the photo album. When successfully finish shooting, a prompt message will pop up.

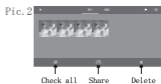
3. APP ONE KEY SHARE FUNCTION



1. Open the APP and click  , enter into media library (Pic.1).
2. Click  , enter into the share interface (Pic.2), choose one or all photos you like to share, click  , choose the social media you like to share the photos (Pic.3).

Reminder: You can share 1 picture or 9 pictures at the same time.
But Only one video can be shared each time.

4. HOW TO SEARCH THE LOST DRONE

- ①. Continue to click **Find drone >** to open the MAP surface to search the aircraft.

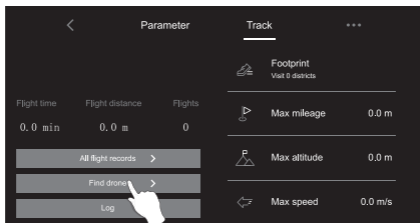

- ②. The last position of lost aircraft will be appeared on the MAP.



Current position of the mobile phone

5. FLIGHT

The Default GPS Mode is BEGINNER MODE:

1. Flight Distance is between 0-30 M.
2. Flight Altitude is between 0-30 M.
3. RTH Altitude is under 20 M.

You can Turn-off the BEGINNER MODE to set the parameters in the APP from the smart phone.

● ● ●
Flight System
Setting





6. SAVE THE PHOTO AND VIDEO TO THE MOBILE APP ALBUM



Open the APP and connect the WIFI with the aircraft, click the  , enter into the media library (Pic.1).



APP album: Choose photo and video and save them in the mobile album, click  , photo and video are saved in the mobile album.



SD card: Click  , choose photo and video and save them in your mobile, click  , photo and video are saved in the mobile album.



NOTE: After shooting and recording finished, photo and video will be saved in the APP album and SD card, the resolution of photo and video saved in the APP album is different that in SD card.

AIRCRAFT FUNCTION PROFILE

1. WAY POINT FLIGHT

— Ensure the mobile internet connected, enter  in the APP, catch the map data of the area when you intend to fly in your mobile device, then connect your mobile device with your aircraft, you can view the map from  in the APP.

— Successfully connect the aircraft WIFI with your smart phone, click  on the App, then you can find a RED CIRCLE(LIMITTED FLIGHT RANGE)/TAKE-OFF POSITION/AIRCRAFT CURRENT POSITION on the map, mark the points (16 points at most) you plan to fly within the RED CIRCLE range on the map.

If you would like to reset the points or flight route, click **Delete single** or **Delete all** . Click **Send** ,confirm to start Way Point Flig

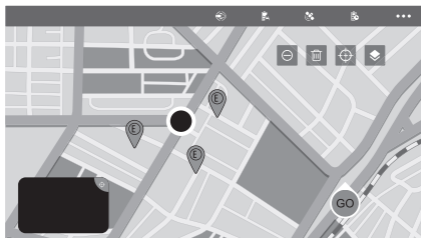

2. POINT OF INTEREST

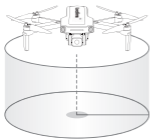

1. Hover the aircraft at the center point to be surrounded.
2. Select the surrounding radius on the APP, and slide to flight.
3. When circling, you can control the left or right direction lever to change the clockwise flight or counterclockwise flight of the aircraft.
4. When circling, you can control the forward direction lever or the backward direction lever to change the circling radius of the aircraft.
5. Click the "Surround Function" icon again on the APP to exit the Surround Function.

3. EMERGENCY STOP

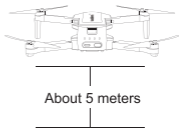



! Clicking once and keep pressing the **STOP** for **3** seconds to enter into Emergency Stop mode. It is activated if the flight height of aircraft within 13 meters; otherwise, it is not activated.

Only stop motors mid-flight in emergency when doing so can reduce the risk of damage or injury.

4. GPS FOLLOW-ME

When the Follow Me function activated, the aircraft **will** follow the GPS in your smart phone to **follow** you wherever you go.

(Make sure the smart phone connect with the aircraft successfully, turn on APP on your smart phone.)

1. Make sure the flight scope is within 10-50 meters.
2. Click  on the APP interface.
3. Waiting for APP aircraft Status to display "Follow Me ready"---Now the aircraft is moving along with the positioning coordinate on the APP.
4. Click the  on the APP interface again to exit the Follow Me mode.



Common Issues:

GPS Follow-me function **will** be affected by the **tall** structures, trees and the living areas with WIFI signal interference.

GPS Follow-me function is not activated if the GPS signal weak or GPS positioning OFF in the mobile device.

* Use in open area and be **mindful** of your surroundings. Aircraft is **NOT** equipped with obstacle avoidance.

5. IMAGE RECOGNITION FOLLOW ME/GESTURE CONTROL

Click , choose , tap on the object or person you want to track, and tap to confirm your selection.

(NOTE: Make sure the size of the frame you mark is the same as the object or person you tap, the frame should not be too large.)

6. HAND GESTURE

Click  on the APP, count down 3 seconds to 0 seconds with the hand motion to take photos or record the video, please follow the tips from the (PIC.1).



PIC.1

7. RETURN-TO-HOME (RTH)

The Return to Home (RTH) function bring the aircraft back to the Take Off Point. This function only can be achieved under GPS mode.

There are 3 types of RTH: Smart RTH/Low-battery RTH/Fail connection RTH

①. Smart Return To Home



Press the Return to Home Button on your remote control or tap on the App of your smart phone, and the remote control will start beeping. Your aircraft will return to the TAKE OFF Point. Press the button again to stop RTH procedure. or alter the left and right joysticks to make the aircraft landing in the safe area.



RTH Button



The app's RTH Button

②. Low-Battery return to home

Low-Battery RTH is triggered when the Flight Battery level is low, When low battery RTH activated, aircraft ascends or descends automatically at the height altitude of 30 meters, then you can alter the left and right joysticks to make it landing in the safe area. Aircraft returns to the take-off point if the current battery level can only support the aircraft long enough to descend from the current altitude.

③. Fail connection RETURN-TO-HOME (RTH)

Aircraft will enter Return to Home Mode if the signal to the remote control is lost. The aircraft will return to the take-off point. The aircraft may link the remote control automatically during the RTH activated. If links successfully, you can re-operate the aircraft.



WARNING:

This aircraft is NOT equipped with obstacle-avoidance.

8. OPTICAL FLOW VISION SYSTEM

The aircraft is equipped with a downward looking optical flow system, which is composed of downward looking visual camera sensors, so that the UAV can hover stably at low altitude without GPS or with weak GPS signals.

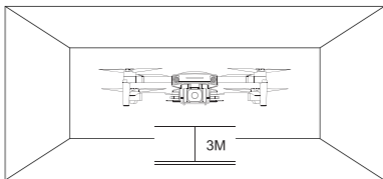

Note:

- (1) The optical flow vision system can only assist in flight when the surrounding environment is full of light and rich in texture but cannot completely replace the user's judgment. Please pay attention to the aircraft situation and APP tips and please DO NOT rely too much on the optical flow vision system.
- (2) The optical flow vision system is ineffective or ineffective in situations where the ambient light is too bright or too dark, mirror surface, pure color smooth ground, water surface, reflective surface, texture sparse surface, etc.
- (3) The best working range of the down view optical flow vision system is below 0.5-3 meters. If it exceeds this range, the positioning effect of the down view optical flow vision system may be poor. Please fly with caution.
- (4) Please ensure that the lens of the optical flow vision system is clear and DO NOT block or interfere the optical flow vision system.
- (5) The optical flow vision system can only be used in the Altitude Mode and change to the GPS mode automatically outdoors after GPS satellite search successfully.



9. CAMERA FUNCTIONS







 Take Photo

 Take Video

ICON ON APP

Click  on the remote control, or click  on the APP, the indicator  will flash once, means the camera takes one photo.

Click  on the remote control, or click  on the APP, the indicator  will keep flashing, means the camera is recording.

Press  again to save the video.

DO NOT take photo during recording.



The Original images and videos are saved in the SD card. Press the SD card slightly to take it out, then insert the card into the card reader and insert into the Type-C outlet of a computer to read the data from SD card. The images can be also viewed in the App.

COMMON SOLUTIONS

If you need any accessories or encounter any problems with this drone, please contact us or visit Loolinn official website. We will help you address the problem asap.

Email: LooLinn123@gmail.com

WhatsApp: +86 157 1103 4183

Official website: <https://www.LooLinn.com>

1. The mobile device and remote control cannot be connected.
Check the status of control signal icon on the APP if changed.
2. The image transmission is jammed or easily out of control and disconnected.
 - ① Adjust the antenna angle to align with the aircraft, and ensure no obstruction in the middle position.
 - ② Change the flight area. Please DO NOT fly near high buildings or signal towers.
 - ③ The aircraft hovers unsteadily.
3. The aircraft hovers unsteadily.
 - ① Change the flight area. Please DO NOT fly near high buildings or signal towers.
 - ② Conduct aircraft compass calibration and horizontal calibration.
 - ③ Judge whether the strong wind affects the flight or not.
 - ④ Judge whether the fan blade and the arm are deformed or not.
4. The GPS accuracy of the aircraft is not accurate or cannot pass the GPS accuracy test.
 - ① Go to an open area outdoors where GPS signal can be searched 6 or more satellites.
 - ② Walk around the aircraft at close range.
 - ③ Replace the mobile device.
 - ④ Do not test it under high buildings.
5. The battery cannot be charged.
Re-plug and unplug the charger or re-load and unload the battery.
6. Short flight time.
Overcharge or discharge the battery, also the battery life reducing can be caused by the high-temperature environment. It is recommended to store the remaining 60% of the battery power and recharge it fully before using.
7. Unclear shooting.
 - ① Check whether the camera protective film is removed or not.
 - ② Use it under the good light environment.
 - ③ Set shooting parameters from the camera setting in the APP.
8. The camera is misty.
 - ① Wet weather causes fog on the camera. Replace the storage place of the aircraft.
 - ② Place desiccant in the protective cover of camera during storage.
9. Pictures or videos taken are lost.
When recording a video, you must end the recording operation, otherwise the video may be damaged or lost.

SPECIFICATIONS

● Drone

MODEL: F5 PRO

Weight (Including Battery): 249g / 8.8oz

Flight Time: About 20 min

Motor Model: 1503

Operating Temperature Range:

32° to 104° F (0° to 40° C)

Satellite Systems: GPS/GLONASS

Dimensions (LxWxH): Unfolded: 27.3x30.3x5.6 (cm)

Folded: 14.1x8.9x5.6 (cm)

● Gimbal Stabilization: tilt, roll

Controllable Range: Adjusted angle of camera (up and down):

About -90° To+0°

● Camera

Lens:FOV: 85°

Equivalent Focal Length: 2.5M

Focus range: Fixed-focus

Resolution of photo: Phone 3840X2160P

SD card 3840X2160P

Resolution of video: Phone 1280X720P

SD card 3840X2160P

Photo Format: JPEG

Video Format: MP4

Supported SD Cards: Micro SD card (Class

10/U1 or later) 32G-128G

Supported File Systems: FAT32

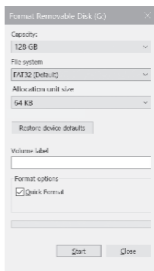

● 5G Transmission

Operating Frequency: 5.15-5.35 GHz; 5.725-5.825 GHz

Supported Transmission Protocol: 802.11a; 802.11n20; 802.11n40

Video Transmission Frame Rate: 20FPS

- APP / Live View
Mobile App: Loolinn Pro

CONFIGURATION	STORAGE METHOD		RESOLUTION	TRANSMISSION FRAME RATE
4K	Phone	Photo	3840X2160P	
		Video	1280X720P	20 fps
	SDcard	Photo	3840X2160P	
		Video	3840X2160P	20 fps
2.7K	Phone	Photo	3840X2160P	
		Video	1280X720P	30 fps
	SDcard	Photo	2976X1680P	
		Video	2976X1680P	30 fps

Required Operating System:IOS 9.0 or later/Android 5.0 or later

- **Remote Control**

Operating Frequency: 2.4G

Max operating distance: Up to 500M (Outdoor and Unobstructed)

Battery: 300mAh Li-polymer

Charging time: about 30 min

Operating time: about 1.5 hours

Operating Voltage: 3.7V

Mobile Device Holder: 4.7" to 6.5" Smart Phones

Operating Temperature: 32° to 104° F (0° to 40° C)

- **Intelligent Flight Battery**

Capacity: 1500mAh

Voltage: 7.4V

Battery Type: Li-polymer

Energy: 11.11Wh

Net Weight: 73g / 2.6oz

Max Charging Power: 10W

Max Charging Time: **About 3 hours** (Depending on Charging Power)

Charging Temperature Range: 32° to 104° F (0° to 40° C)

- **Charging cable: Type-C**

Voltage: 5V = 2A

Rated Power: ≤ 10 W

PARTS LIST (INCLUDED)



Blade A X2



Blade B X2



Type-C cable X1
Only for charging



Instructions X1



Screw driver X1



Screw X8



Joystick parts X2

COMMON PROBLEMS AND SOLUTIONS

THE PROBLEM	REASON	COUNTERMEASURES
Drone lights flashing and no response from the drone when operating.	<ol style="list-style-type: none"> 1. Remote is not synced to the drone. 2. Insufficient battery power. 	<ol style="list-style-type: none"> 1. Refer to the Quick Start guide and re-sync the drone. 2. Recharge the battery.
The blades spin, but the drone cannot takeoff.	<ol style="list-style-type: none"> 1. Insufficient battery power. 2. The blades distorted. 	<ol style="list-style-type: none"> 1. Recharge the battery. 2. Replace the blades.
The quadcopter shakes heavily.	The blades distorted.	Replace the blades.
Drone cannot stay balanced in flight.	<ol style="list-style-type: none"> 1. The blades distorted. 2. The motor doesn't work properly. 	<ol style="list-style-type: none"> 1. Replace the blades. 2. Replace the motor.

